

A0	----	初版发行	2017. 3. 17	CML
A1	ECN-20210817001	增加 CUL Logo	2021. 8. 19	CML

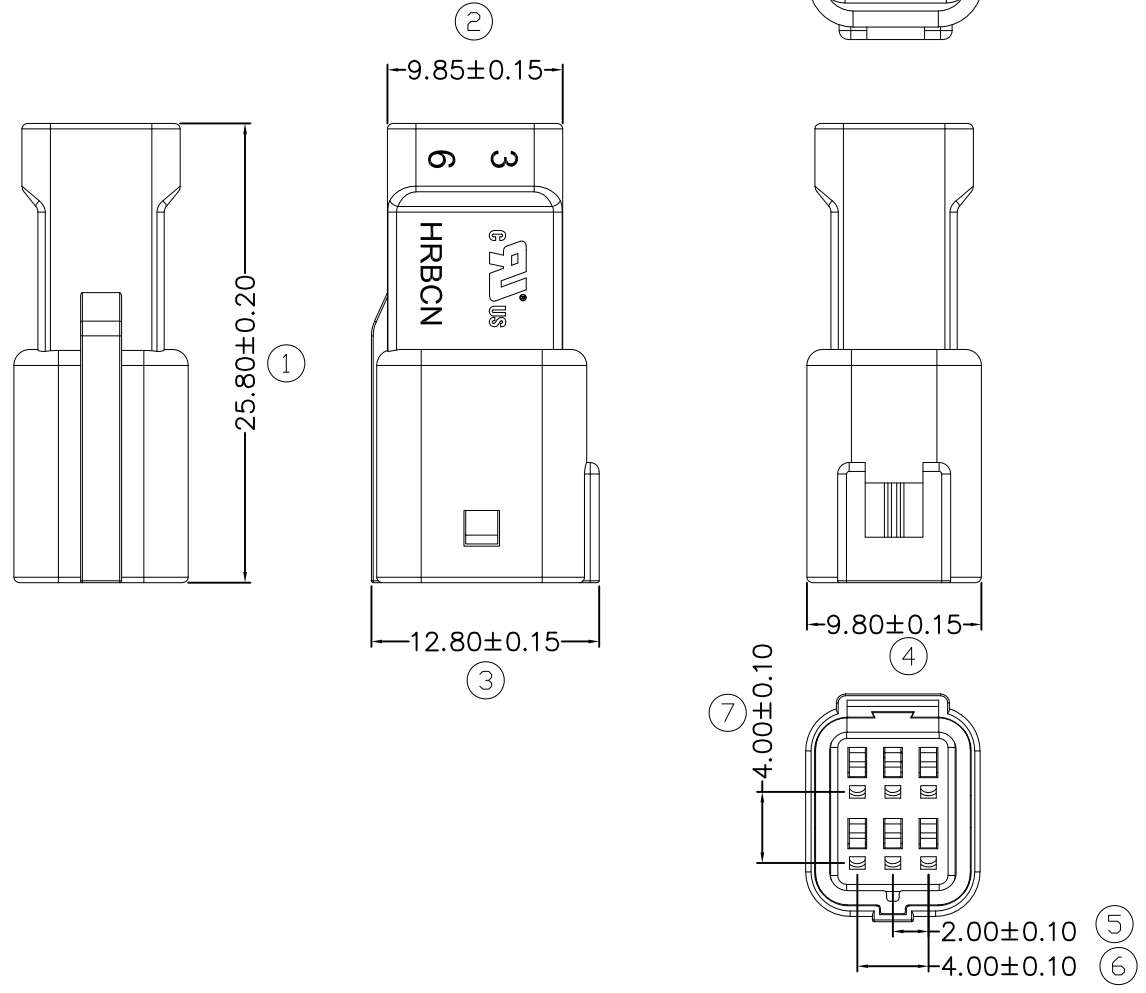

- SPECIFICATIONS:**
- Current Rating: 3A AC, DC Max.
 - Voltage Rating: 100V AC, DC
 - Operating Temperature: -40°C ~ +130°C
 - Insulation Resistance: 1000MΩ Min.
 - Withstanding Voltage: 1000V AC/minute
 - Material: Housing: PBT UL94V-0, natural (white)
 Seal ring: Silicon rubber
 Seal plug: Silicon rubber
 Seal ring holder : PBT UL94V-0, yellow

M20033-2X3-C

Color:
 W: White
 B: Black
 G: Gray

料号 (Part No.)	M20033-2x3-C		UNIT:mm			 THIRD ANGLE PROJECTION 	核准 Approved:	日期 Date:
产品名称 (Product Name)	2.0防水连接器		Tolerance:	Angular Dim.			审核 Checked:	日期 Date:
比例 (Scale)	1:1	版本 (Version)	.XXX ±0.05	.XX° ±1°			设计 Designed:	日期 Date: 2021. 8. 19
		A1	.XX ±0.10	.X° ±2°				
			.X ±0.20	X.° ±3°				

A0	----	初版发行	2017. 3. 17	CML
A1	ECN-20210817001	增加 CUL Logo	2021. 8. 19	CML

- SPECIFICATIONS:**
- Current Rating:3A AC,DC Max.
 - Voltage Rating:100V AC,DC
 - Operating Temperature:-40℃~+130℃
 - Insulation Resistance:1000MΩ Min.
 - Withstanding Voltage:1000V AC/minute
 - Material:Housing:PBT UL94V-0,natural(white)
 Seal ring:Silicon rubber
 Seal plug:Silicon rubber
 Seal ring holder : PBT UL94V-0,yellow

M20033-2X4-C

Color:
W: White
B: Black
G: Gray

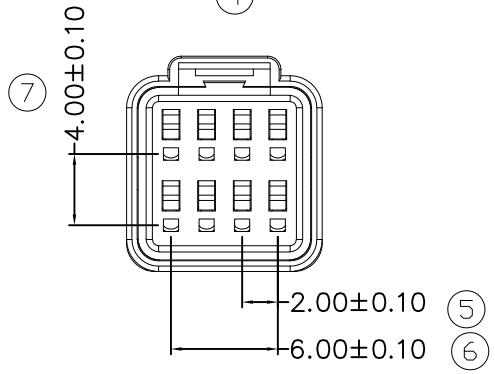
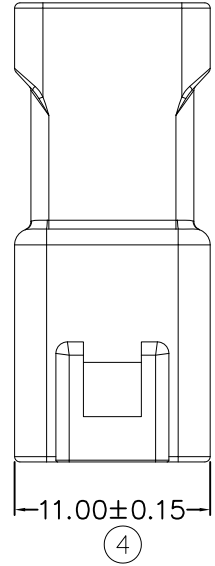
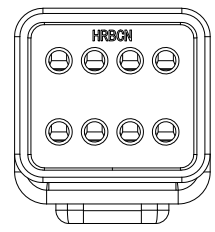
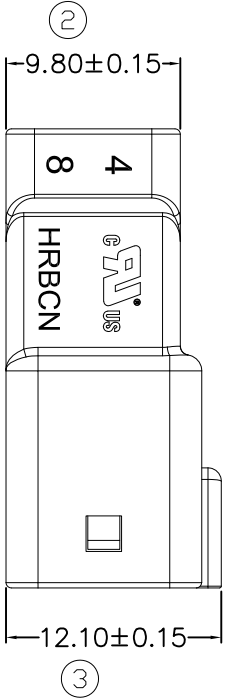
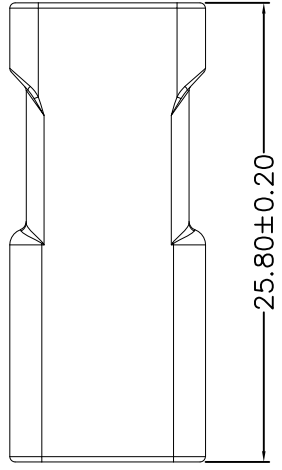

料号 (Part No.)	M20033-2x4-C		
产品名称 (Product Name)	2.0防水连接器		
比例(Scale)	1:1	版本(Version)	A1

UNIT:mm	
Tolerance:	Angular Dim.
.XXX ±0.05	.XX° ±1°
.XX ±0.10	.X° ±2°
.X ±0.20	X.° ±3°

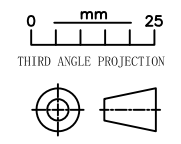

核准Approved:		日期Date:	
审核Checked:		日期Date:	
设计Designed:	CML	日期Date:	2021. 8. 19